

BLACKMER PISTON AIR/RELIEF VALVE (w/o spring) CONVERSION KIT

964608 INSTRUCTIONS
Page 1 of 8 AND PARTS LIST
NO. 201-H00

INSTALLATION OPERATION & MAINTENANCE INSTRUCTIONS WITH PARTS LIST

For Pump Models: TXH3C, TXH3B, TXH3A, TXD2.5A, TXD1225A

Section	201
Effective	Dec 2009
Replaces	May 2009

TABLE OF CONTENTS	Page
SAFETY DATA	1-2
VALVE DATA	2
Air/Relief Valve Technical Data	2
Initial Air/Relief Valve Settings	2
INSTALLATION	2
Pre-Installation Cleaning	2
Mounting the Air/Relief Valve	3
Air/Relief Valve Adjustment	3
MAINTENANCE	5
Maintenance and Inspection Schedules	5
Air/Relief Valve Removal and Disassembly	5
Air/Relief Valve Assembly	6
PARTS LIST	7

NOTICE:

Keep this document with the appropriate Blackmer pump Installation, Operation and Maintenance instruction manual.

NOTICE:

Review and follow all hazard warnings provided in the appropriate Blackmer pump Installation, Operation and Maintenance instruction manual.

Blackmer pump manuals and parts lists may be obtained from Blackmer's website (www.blackmer.com) or by contacting Blackmer Customer Service

NOTE: Numbers in parentheses after individual parts indicate reference numbers on Blackmer Parts List

NOTE: A pump with a standard relief valve may be converted to use the Piston Air Valve with the installation of a Piston Air Valve Kit. See the Parts List, Table 3 for applicable pump models.

SAFETY DATA



This is a SAFETY ALERT SYMBOL.

When you see this symbol on the product, or in the manual, look for one of the following signal words and be alert to the potential for personal injury, death or major property damage



Warns of hazards that WILL cause serious personal injury, death or major property damage.



Warns of hazards that CAN cause serious personal injury, death or major property damage.



Warns of hazards that CAN cause personal injury or property damage.

NOTICE:

Indicates special instructions which are very important and must be followed.

NOTICE:

Blackmer Air/Relief Valves **MUST** only be installed in systems which have been designed by qualified engineering personnel. The system **MUST** conform to all applicable local and national regulations and safety standards.

This manual is intended to assist in the installation and operation of the Blackmer Air/Relief Valves, and **MUST** be kept with the system.

Blackmer Air/Relief Valve service shall be performed by qualified technicians **ONLY**. Service shall conform to all applicable local and national regulations and safety standards.

Thoroughly review this manual, all instructions and hazard warnings, **BEFORE** performing any work on the Blackmer Air/Relief Valves.

Maintain **ALL** system and Blackmer truck pump operation and hazard warning decals.

SAFETY DATA

⚠ WARNING



Hazardous machinery can cause serious personal injury or property damage.

Failure to set the vehicle emergency brake and chock wheels before performing service can cause severe personal injury or property damage.

⚠ WARNING



Hazardous pressure can cause personal injury or property damage.

Disconnecting fluid or pressure containment components during pump operation can cause serious personal injury, death or major property damage

⚠ WARNING



Hazardous machinery can cause serious personal injury.

Failure to disconnect and lockout electrical power or engine drive before attempting maintenance can cause serious personal injury or death

⚠ WARNING



Hazardous or toxic fluids can cause serious injury.

If pumping hazardous fluids, the system must be flushed and decontaminated prior to performing service or maintenance.

⚠ WARNING



Hazardous fluids can cause fire, serious personal injury or property damage.

All fluids pumped must be compatible with piston material. Incompatibility can cause fire, serious personal injury or property damage.

⚠ WARNING



Hazardous pressure can cause serious personal injury or property damage.

Failure to relieve system pressure prior to performing pump service or maintenance can cause personal injury or property damage.

NOTICE:

Installation and maintenance shall be performed by qualified technicians only, following the appropriate procedures and warnings as presented in this manual and the appropriate pump installation, operation, and maintenance instructions.

VALVE DATA

AIR VALVE TECHNICAL DATA

Maximum Pump Pressure	125 psi (8.6 Bar)
Maximum Air Pressure	55 psi (3.8 Bar)
Minimum Air Pressure	10 - 20 psi (0.7 - 1.4 Bar)
Maximum Operational Temperature	240°F (115°C)
Minimum Operational Temperature	-20°F (-29°C)

INITIAL AIR VALVE SETTINGS

Pump Operating Pressure: _____
Low Pressure Setting: _____
High Pressure Setting: _____
Peak Pressure Setting: _____

INSTALLATION

The Blackmer air/relief valve is piston type relief valve. The air/relief valve is designed to work with a fluid flow detector, which controls the pneumatic air pressure behind the piston.

With the air pressure on the piston, the valve controls pump pressure in the conventional manner. Two air regulators control the air pressure to the piston air valve. One regulator is for the low pressure setting and one regulator is for the high pressure setting.

NOTICE:

The Blackmer air/relief valve is designed for fuel oil service. Contact factory for all other fluids.

PRE-INSTALLATION CLEANING

Foreign matter entering the pump WILL cause extensive damage. The pump and the surrounding area MUST be cleaned prior to attempting air/relief valve installation. The supply tank and intake piping MUST be cleaned and flushed prior to installation and operation.

NOTICE:

An air check valve must be installed in the vehicle air supply line to ensure minimum safe air pressure for the brake system.

MOUNTING THE AIR/RELIEF VALVE TO THE PUMP

Refer to Pump Parts List 201-C01.

1. Remove the pump relief valve cap (1), and turn the adjusting screw (2) counter clockwise to relieve spring tension. **(if equipped)**
2. Remove and discard the pump's four relief valve cover bolts (5 & 5A). Remove the cover (4), spring guide (7), spring (8), and gasket (10). Clean and inspect the gasket surfaces, repairing as necessary.
3. Install a new gasket (10).
4. Attach the Blackmer Air/Relief Valve Conversion Kit to the pump using the four new bolts provided (5 & 5C) and washers (5A & 5B). Ensure the valve cover (4) is positioned so that the air inlet pipe hole is accessible to attach the air line.
5. Torque the air valve mounting bolts per Table 1.

TORQUE* lbs in (Nm)	150 (16.9)
----------------------------	-------------

*Torque specification tolerance is +/- 10 lbs in (1.08 Nm).

Table 1

AIR/RELIEF VALVE ADJUSTMENT

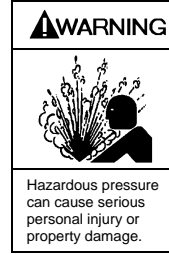

Failure to relieve system pressure prior to performing pump service or maintenance can cause personal injury or property damage.

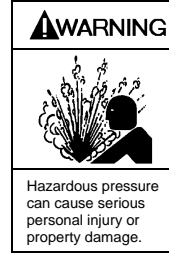

Incorrect settings of the Blackmer air/relief valve can cause system component failure, personal injury and property damage.

The pump mounted Blackmer air/relief valve low and high pressure settings are adjustable within a specific range to suit the engine operating speed and conditions. Air valve adjustment is done by adjusting the air regulators. Refer to Table 2 for the air valve pressure settings.

Attach a suitable pressure gauge at the pump discharge gauge port (73) to make the required air valve adjustments. (see Pump Parts List 201-C01) Record the air valve and pump operating pressures in the "Initial Air Valve settings" Chart on page 2 of this manual.

	AIR PRESSURE PSI (bar)	PUMP R/V SETTING PSI (bar)
Low	10 - 20 (0.7 - 1.4)	20 - 45 (1.4 - 3.1)
High	33 - 55 (2.3 - 3.8)	75 - 125 (5.2 - 8.6)

Table 2

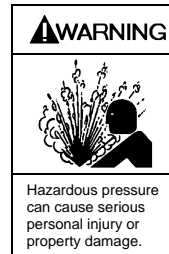

Air pressure MUST NOT exceed 55 psi (3.8 bar).

INSTALLATION

LOW PRESSURE ADJUSTMENT

The air valve low pressure adjustment **MUST** be set first.

NOTICE:

The air valve low pressure setting regulates the delivery hose pressure when the nozzle is closed. Adjust the air valve only high enough to open the flow sensing valve.

1. Adjustment **MUST** be made with the pump at normal idle speed - 200 RPM minimum.
2. **SLOWLY** close the delivery nozzle, allowing the pump pressure to be relieved. Note the gauge pressure reading.
3. Lift the adjusting handle on the low pressure regulator to allow air regulator setting adjustment. Turn the low pressure air regulator clockwise to increase the pressure setting, or counterclockwise to decrease the pressure setting. Refer to Table 2 for recommended setting ranges.
4. After setting the air regulator pressure, push down on the adjusting knob to lock into position.
5. Open and close the delivery nozzle several times to ensure the correct setting. Repeat steps 2 - 4 until the required low pressure setting is achieved.

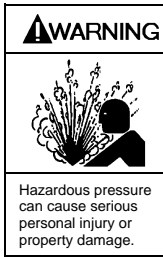

Air supply pressure to the relief valve **MUST NOT exceed 55 psi (3.8 bar).**

Air supply pressure above 55 psi (3.8 bar) will cause system pressure to exceed 125 psi (8.6 bar) which can result in component failure, personal injury and property damage.

HIGH PRESSURE ADJUSTMENT: Do not exceed the maximum pressure listed in Table 2.

1. Adjustment **MUST** be made with the pump at normal operating speed and with pressure behind the air valve piston.
2. **SLOWLY** close the delivery nozzle, allowing the pump pressure to be relieved. Note the gauge pressure reading.
3. Lift the adjustment knob on the high pressure regulator to allow air regulator setting adjustment. Turn the high pressure air regulator clockwise to increase the pressure setting, or counterclockwise to decrease the pressure setting. Refer to Table 2 for recommended setting ranges.
4. After setting the air regulator pressure, push down on the adjusting knob to lock into position.
5. Open the delivery nozzle and observe the pump's discharge gauge. Repeat steps 2-4 until required high pressure setting is achieved.
6. After the final adjustment is made, ensure that the air regulator adjustment knobs are pushed down and locked into position. Inspect all air lines for leaks and replace as necessary.

MAINTENANCE

NOTICE:

Maintenance shall be performed by qualified technicians only, following the appropriate procedures and warnings as presented in this manual and the appropriate pump installation, operation, and maintenance instructions.

⚠WARNING



Hazardous machinery can cause serious personal injury or property damage.

Failure to set the vehicle emergency brake and chock wheels before performing service can cause severe personal injury or property damage.

⚠WARNING



Hazardous pressure can cause personal injury or property damage.

Disconnecting fluid or pressure containment components during pump operation can cause serious personal injury, death or major property damage

⚠WARNING



Hazardous machinery can cause serious personal injury.

Failure to disconnect and lockout electrical power or engine drive before attempting maintenance can cause serious personal injury or death

⚠WARNING



Hazardous or toxic fluids can cause serious injury.

If pumping hazardous fluids, the system must be flushed and decontaminated prior to performing service or maintenance.

⚠WARNING



Hazardous fluids can cause fire, serious personal injury or property damage.

All fluids pumped must be compatible with piston material. Incompatibility can cause fire, serious personal injury or property damage.

⚠WARNING



Hazardous pressure can cause serious personal injury or property damage.

Failure to relieve system pressure prior to performing pump service or maintenance can cause personal injury or property damage.

AIR/RELIEF VALVE MAINTENANCE AND INSPECTION SCHEDULES

Valve Assembly Part	Inspection Schedule	Action Required
Breather Vent (6)	Weekly	If leakage is present, IMMEDIATE valve service is required.
Air Valve Assembly	Annually	Disassemble, inspect U-cup / Quad Ring seals and replace if cracked, blistered or worn.
Piston Assy. (8)	3 Years (Or Less)	REPLACE

AIR VALVE REMOVAL AND DISASSEMBLY

- Remove the cap (1) from the air valve assembly. Remove and discard the cap O-ring (88).
- Remove the four capscrews (5 & 5C) and washers (5A & 5B).
- Carefully remove the air valve assembly, and if necessary, the valve (9).
- Remove and discard the gasket (10). Clean gasket areas.
- Clean any foreign matter from the breather vent.
- Remove the piston assembly (8). Inspect the coating on the piston outer diameter for scratches, wear and surface damage. Discard the piston if the coating is worn or damaged. Check that the attachment between the follower and piston is secure.
- Remove the U-cup (7) and quad ring seals (7A), being careful not to scratch the grooves in the piston cover (4) and discard.
- Thread the adjusting bushing (2C), CLOCKWISE into the valve cover (4) until flush with bottom surface, see parts list drawing Figure 1.

AIR VALVE ASSEMBLY

NOTICE:

Prior to assembly, the piston outer diameter and piston cover bore & U-cup / Quad Ring grooves must be lightly coated with a lithium based grease. Remove any grease in the breather vent hole.

1. Install the U-cup (6) and Quad Ring (7) as shown in the parts list drawing on page 6). Install the U-cup seal with the V-groove feature facing the air supply. Install the Quad Ring in the cover groove on the liquid side of the valve. The U-Cup and Quad Ring must be oriented as shown to properly seal and prevent cross-contamination between the air supply and product.
 2. Insert the piston assembly (8) into the adjustment bushing (2C).
 3. Install a new gasket (10) and insert the four capscrews (5 & 5C) with washers (5A & 5B) into the air valve assembly.
-

NOTICE:

The relief valve follower , which is secured to the piston, must fit over the boss on the relief valve (9).

4. If removed, reinstall the valve (9). Mount the air valve assembly to the pump, ensuring that the gasket is properly seated. Torque the capscrews (5 & 5C) to the appropriate value depicted in Table 1.
5. With a new O-ring (88) installed, attach the air valve cap (1) securely.
6. Adjust the new valve as provided in the "Air Valve Adjustment" section of this manual

PARTS LIST

Fig. 1

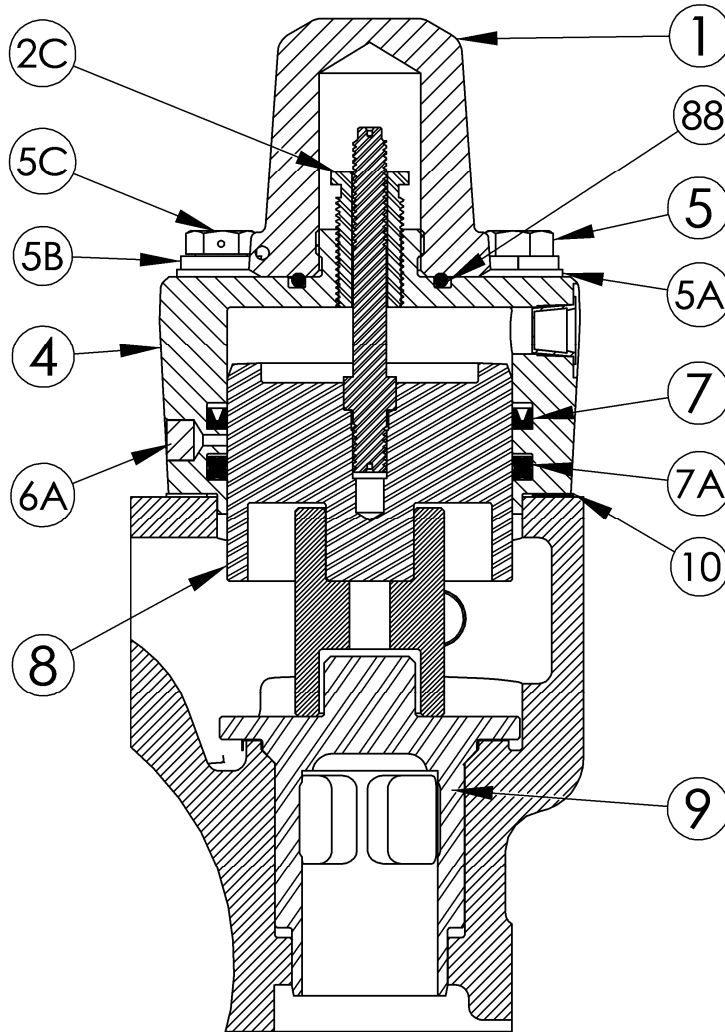

Table 3 PARTS LIST for Piston Air Valve Style ¹

REF. NO.	PART NAME		PARTS PER VALVE	PART NO.
1	Cap		1	411754
2C	Adjustment Bushing		1	501703
4	Cover		1	411758
5	Capscrew		3	920448
5A	Flat washer		4	909662
5B	Lockwasher		4	909649
5C	Capscrew w/ Hole		1	920465
7	U-cup packing ²	FKM	1	495030
7A	Quad Ring Seal ²	FKM	1	495033
6	Breather vent		1	495029
8	Piston Assembly – includes 1 ea.: Piston, Adjusting Rod, Follower		1	891732
9	Valve ³	Standard	1	451623
		Corrosion Resistant		451624
10	Gasket ²		1	531603
88	O-Ring ²	FKM	1	701979
	Conversion Kit ³	FKM	—	891730
	Seal Kit ²	FKM	—	891713

¹ Valves prior to May 2009 used two U-Cup packings (7), no Quad Ring Seal (7A) and a different Piston Assembly (8) construction. All parts as listed above may be used in the previous valves

² Parts included in Seal Kit

³ Conversion Kit includes all above parts EXCEPT the Valve (ref. 9).



1809 Century Avenue, Grand Rapids, Michigan 49503-1530 U.S.A.
Telephone: (616) 241-1611 • Fax: (616) 241-3752
E-mail: blackmer@blackmer.com • Internet Address: www.blackmer.com